

03 OMNI-3175-BT

Industrial Modular Touch Panel Solutions

17" Modular HMI Panel PC with Intel® Celeron® J1900/ N2807 Processor

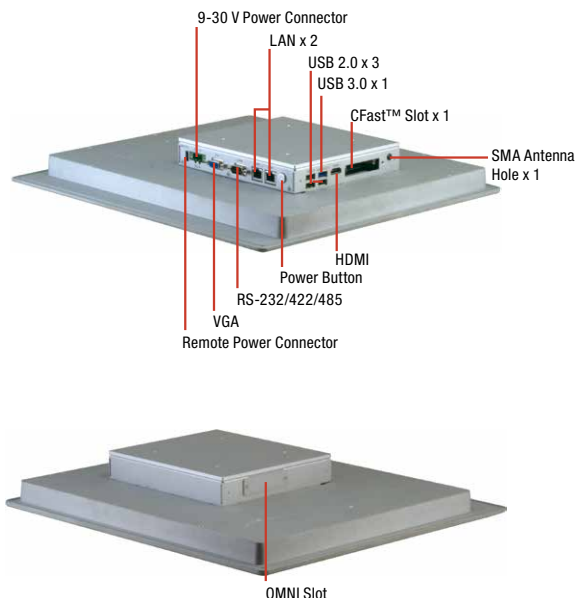

Features

- 17" WXGA (1280 x 1024) TFT LCD Display
- Intel® N2807/J1900 Processor
- P-CAP or Resistive Touch Support
- Aluminum Design
- IP65 Compliant Front Bezel
- Fanless Operation
- Easily Expandable I/O by AAEON OMNI I/O Modules



Specifications

System	
Processor	Intel® N2807 processor, 1.58 GHz Intel® J1900 processor, 2 GHz
System Memory	204-pin DDR3L 1333MHz SODIMM x 1, up to 8 GB, (J1900) 204-pin DDR3L 1333MHz SODIMM x 1, up to 4 GB, (N2807)
LCD/CRT Controller	Integrated in processor
Ethernet	Intel® I211, 10/100/1000Base-TX x 2
I/O Port	USB 2.0 type A x 3 USB 3.0 type A x 1 SMA Antenna hole x 1 HDMI x 1 CFast x 1 DB-9 Type RS-232/422/485 x 1 RJ-45 x 2 for 10/100/1000Base-TXX DB-15 x 1 for VGA 3-pin terminal block x1 for 9~30 Vdc power input LED Power on/off switch x1 (Power on = Orange, Power off =N/A)
Storage Disk Drive	CFast™ x 1, 2.5" SATA HDD bay x 1
Expansion Slot	Mini card x 2 (Testing Compatibility Only) SIM card x 2 PCIe x 1 connector (AAEON PIN Define)
OS support	Windows® 7, Windows® 8, Windows® 10, Linux kernel 2.6.x or above
Mechanical	
Construction	Aluminum design (IP65 Front Frame)
Mounting	Wall/VESA Mount/Desktop (Optional panel mount kits)
Dimension (mm)	16.14" x 14.57" x 2.32" (410mm x 370mm x 59mm)
Gross Weight	15.84 lb (7.2 kg)
Environmental	
Operating Temperature	-10°C ~ 55°C (J1900), -10°C ~ 60°C (N2807) with 0.5 m/s airflow (CF & HDD)
Storage Temperature	-4°F ~ 158°F (-20°C ~ 70°C)
Storage Humidity	90% @40°C; non-condensing
Anti-Vibration	1 Grms / 5~ 500Hz / operation – with HDD
Certification	CE/FCC class A
Power Supply	
DC input	DC 9 (min) ~ 30 (max) V w/3-pin terminal block, ATX Power function
LCD	
Display type	17" TFT-LCD, LED
Max Resolution	1280(H) x 1024(V)
Max. Colors	16.7M colors (RGB 6-bits + Hi-FRC data)
Luminance	350 cd/m ²
Viewing Angle	170°(H), 160°(V)
Back Light	LED
Back Light MTBF (hours)	—
Touchscreen	
Type	P-CAP/ 5-wire resistive
Light Transmission	P-CAP (≥85%), 5-wire Resistive (80% ± 5%)

Dimension

Unit: mm

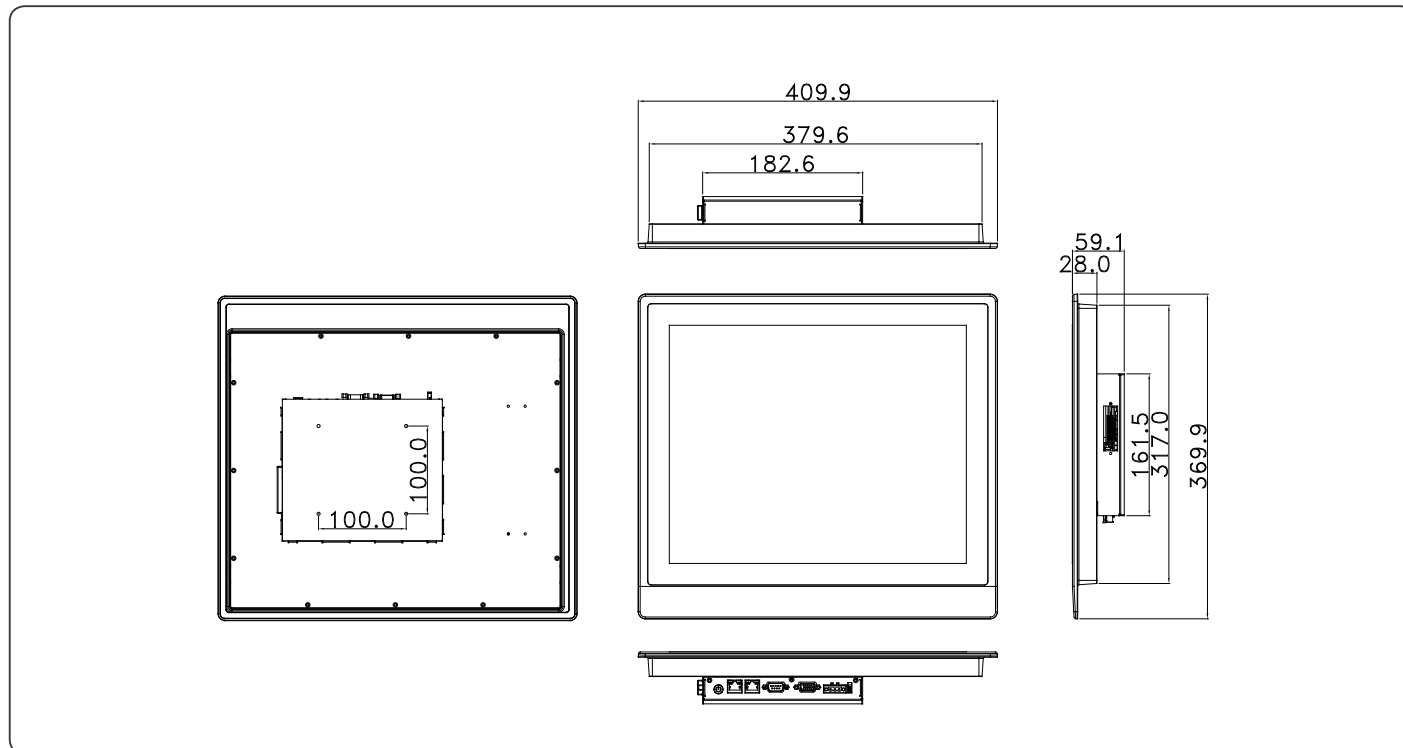

Ordering Information

	Part Number	Display Type	Max Resolution	Luminance	View Angle	CPU	LAN	USB 3.0	USB 2.0	RS-232/422/485	Storage	RAM	Display	Expansion	Mounting	Power	Operating Temp.	Touch
Panel PC	OMNI-3175HTT-BT-A1-1010	17" TFT LCD	1280 x 1024	350 cd/m ²	170°(H) 160°(V)	Intel® J1900, 2 GHz	2	1	3	1	CFast™ x 1, 2.5" SATA HDD x 1	DDR3L, up to 8 GB	VGA x 1	Mini-Card x 2 (Full Size) OMNI Module	VESA 100/ Panel mount	DC 9~30V	-10°C~55°C with airflow	5-wire Resistive
	OMNI-3175HTT-BT-A2-1010	17" TFT LCD	1280 x 1024	350 cd/m ²	170°(H) 160°(V)	Intel® N2807, 1.58 GHz	2	1	3	1	CFast™ x 1, 2.5" SATA HDD x 1	DDR3L, up to 8 GB	VGA x 1	Mini-Card x 2 (Full Size) OMNI Module	VESA 100/ Panel mount	DC 9~30V	-10°C~60°C with airflow	5-wire Resistive
	OMNI-3175HTT-BT-A3-1010	17" TFT LCD	1280 x 1024	350 cd/m ²	170°(H) 160°(V)	Intel® J1900, 2 GHz	2	1	3	1	CFast™ x 1, 2.5" SATA HDD x 1	DDR3L, up to 8 GB	VGA x 1	Mini-Card x 2 (Full Size) OMNI Module	VESA 100/ Panel mount	DC 9~30V	-10°C~55°C with airflow	Projected capacitive
	OMNI-3175HTT-BT-A4-1010	17" TFT LCD	1280 x 1024	350 cd/m ²	170°(H) 160°(V)	Intel® N2807, 1.58 GHz	2	1	3	1	CFast™ x 1, 2.5" SATA HDD x 1	DDR3L, up to 8 GB	VGA x 1	Mini-Card x 2 (Full Size) OMNI Module	VESA 100/ Panel mount	DC 9~30V	-10°C~60°C with airflow	Projected capacitive
Panel Kit	OMNI-317DHTT-KIT-A1-1010	17" TFT LCD	1280 x 1024	350 cd/m ²	170°(H) 160°(V)	—	—	—	—	—	—	—	—	—	—	—	-10°C~60°C with airflow	5-wire Resistive
	OMNI-317DHTT-KIT-A2-1010	17" TFT LCD	1280 x 1024	350 cd/m ²	170°(H) 160°(V)	—	—	—	—	—	—	—	—	—	—	—	-10°C~60°C with airflow	Projected capacitive
CPU Box Kit	OMNI-BT-KIT-A1-1010	—	—	—	—	Intel® J1900, 2 GHz	2	1	3	1	CFast™ x 1, 2.5" SATA HDD x 1	DDR3L, up to 8 GB	VGA x 1	Mini-Card x 2 (Full Size) OMNI Module	VESA 100/ Panel mount	DC 9~30V	-10°C~55°C with airflow	—
	OMNI-BT-KIT-A2-1010	—	—	—	—	Intel® N2807, 1.58 GHz	2	1	3	1	CFast™ x 1, 2.5" SATA HDD x 1	DDR3L, up to 8 GB	VGA x 1	Mini-Card x 2 (Full Size) OMNI Module	VESA 100/ Panel mount	DC 9~30V	-10°C~60°C with airflow	—

Note: * RAM not included * Panel Mount Kit (Optional)

Packing List

- Phoenix Power Connector
- Product DVD
- OMNI-3175-BT

Optional Accessories

- **AP-0T9789LA1000**
LCD monitor Stand 230mm, LA-100
- **1702031802**
Power Cord (US Type)
- **1702031803**
Power Cord (European Type)
- **170203180E**
Power Cord (Japanese Type)
- **1255901202**
19V 120W Power Adapter w/ 3p phoenix block
- **9741317500**
Panel Mount Kit for OMNI-3175-BT
- **1700021500**
Remote Switch Cable, 150 cm

OMNI Module (with AAEON Interface)

- **9741215501**
WiFi & SIM Card Module (Mini-Card WiFi Module is not Included)
- **9741215502**
Dual LAN Module
- **9741215503**
USB / COM / LAN Module
- **9741215504**
COM Port Module
- **9741215505**
Isolated COM Port module
- **9741215506**
DIO Module
- **9741215507**
CAN Bus Module
- **9741215508**
Audio Module
- **9741215510**
HMS Kit
- **9741215511**
COM x 4, DIO x16 Module

Wide Temperature DRAM

- **9761215500**
2GB Wide Temperature DRAM (-40°C ~ 95°C)
 - **9761215501**
4GB Wide Temperature DRAM (-40°C ~ 95°C)
 - **9761215502**
8GB Wide Temperature DRAM (-40°C ~ 95°C)
- **Users should select the wide temperature DRAM above and use wide temperature storage devices if the OMNI panel pc is to be operated at over 40°C.

03 Accessories

9741215501 - WiFi & SIM Card Module

Mini PCIe Slot x 2, for OMNI Panel PC only (wireless Mini-Card Module Excluded)



Features

- Full-size Mini-Card Slot x 2
- SIM Card Slot x 2

Ordering Information

- 9741215501
WiFi & SIM Card Module (wireless Mini-Card Module Excluded)

Dimension Unit: mm

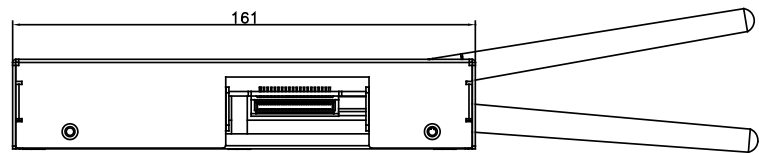
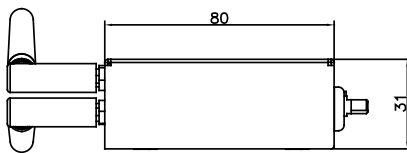

9741215502 - Dual LAN Module

Gigabit Ethernet x 2, for OMNI Panel PC only



Features

- Gigabit Ethernet x 2
- Intel® i21 Chipset

Ordering Information

- 9741215502
Dual LAN Module

Dimension Unit: mm

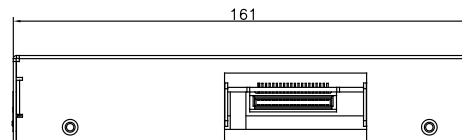
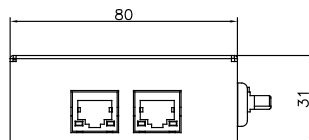

Accessories

9741215503 - USB/COM/LAN Module

USB 2.0 x 2, RS-232/422/485 x 2, Gigabit Ethernet x 1, for OMNI Panel PC only



Features

- USB 2.0 x 2
- RS-232/422/485 x 2 (Selection by External Switch)
- Gigabit Ethernet x 1

Ordering Information

- 9741215503
USB/COM/LAN Module

Dimension Unit: mm

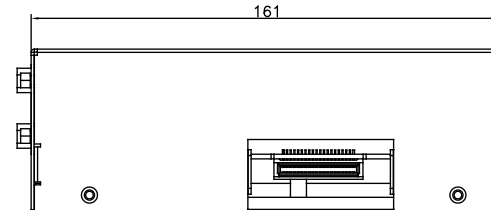
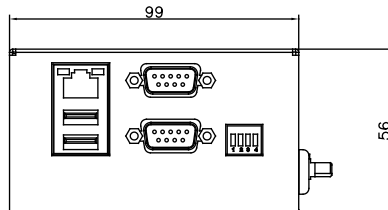

9741215504 - COM Module

RS-232/422/485 x 4, for OMNI Panel PC only



Features

- RS-232/422/485 x 4
- Selection by Jumpers

Ordering Information

- 9741215504
COM Module

Dimension Unit: mm

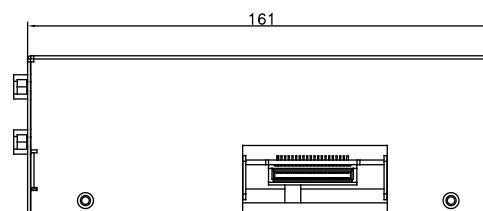
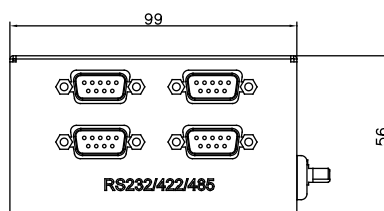

03 Accessories

Industrial Modular Touch Panel Solutions - Accessories

9741215505 - Isolated COM Module

Isolated RS-232/422/485 x 4, for OMNI Panel PC Only



Features

- Isolated RS-232/422/485 x 4
- 2K Vdc Isolation
- Selection by Jumpers

Ordering Information

- 9741215505
Isolated COM Module

Dimension Unit: mm

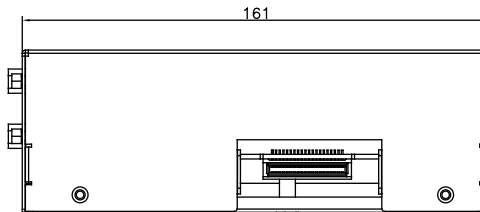
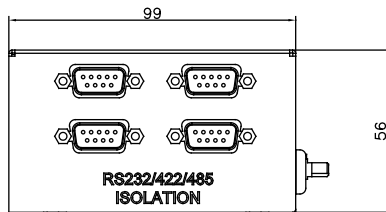

9741215506 - DIO Module

DIO without Isolation x 8, for OMNI Panel PC only



Features

- DIO x 8 (3.3 Vac)

Ordering Information

- 9741215506
DIO Module

Dimension Unit: mm

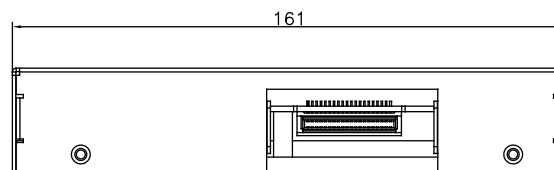
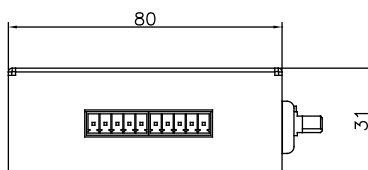

Accessories

9741215507 - CAN Bus Module

CAN Bus with Isolation, for OMNI Panel PC only



Features

- CAN Bus with Phoenix Connectors
- 2K Vdc Isolation
- Provide API and SDK for Windows® OS

Ordering Information

- 9741215507
CAN Bus Module

Dimension Unit: mm

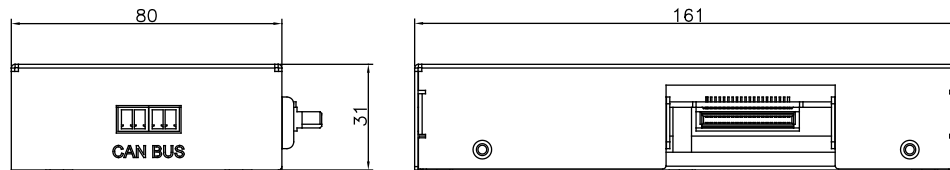

9741215508 - Audio Module

MIC-In x 1, Line-out x 1, for OMNI Panel PC only



Features

- Mic in x 1
- Line out x 1

Ordering Information

- 9741215508
Audio Module

Dimension Unit: mm

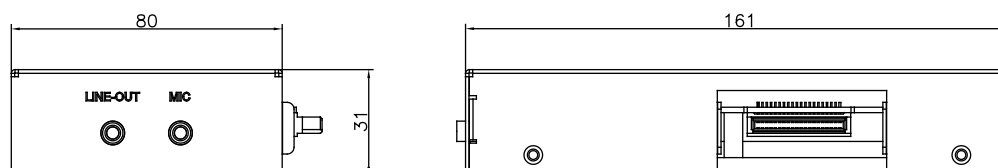

03 Accessories

Industrial Modular Touch Panel Solutions - Accessories

9741215510 - HMS Kit

10/100 Ethernet x 2, for OMNI Panel PC Only



Features

- 10/100 Ethernet x 2, Anybus
- Support All Major Industrial Ethernet and Fieldbus Networks

* Due to communication protocol limit, only for EU region

Ordering Information

- 9741215510
HMS Kit

Dimension Unit: mm

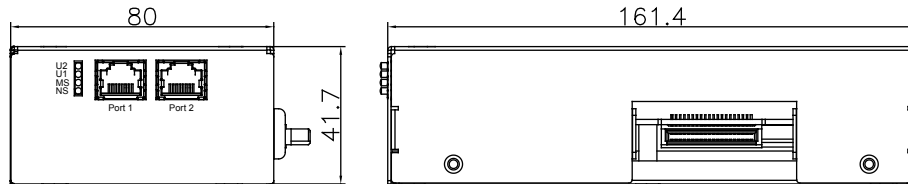

9741215511 - COM x 4, DIOx16 Module

RS-485/422/232 x 4, DIOx16 Module, for OMNI Panel PC only



Features

- Isolated RS-232/422/485 x 4
- Digital I/O x 8

Ordering Information

- 9741215511
COM x 4, DIOx16 Module

Dimension Unit: mm

